

TOSHIBA

Leading Innovation >>>



Applicable to
certain models.

Made In Japan

Digital Inverter
System

Super
Digital Inverter
System



TOSHIBA AIR CONDITIONING
Advancing the **eco**-evolution



Toshiba can help you create a comfortable office
and home while also caring for the environment.

TOSHIBA AIR CONDITIONING

Advancing the **eco**-evolution

SDI Super Digital Inverter

Latest technology: Newly developed DC twin-rotary compressor, Vector-controlled inverter, Larger propeller fan, High efficiency DC fan motor, High efficiency heat-transfer and New grille design has excellent efficiency, not only under rated EER conditions, but also during partial load which is the larger part of actual operating conditions.

Low-noise design: If the outdoor temperature is 30°C or less, operates at under 45 dB

The industry's first magnetic-action control

The new structure allows a huge reduction in energy loss.

The balanced magnetic-action force to rise and the rotor's weight minimized the friction laid on the axis provides excellent operation efficiency.

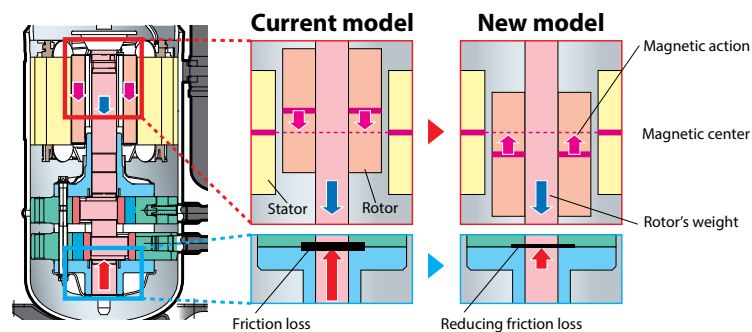

Outdoor temperature operating range in heating (Wider heating operation)

Heater operation is possible starting from an outdoor temperature of -20°C, while cooling operation is possible at -15°C outdoor temperature. Creates a comfortable space even during cold winters.

Frost protection

8°C operation for frost protection is possible for the combination with Super Digital Inverter. (4-Way and Slim Duct series 4)

Sub cool path

Improve reliability for smooth drainage. The outdoor unit of New Super Digital Inverter is equipped with "Sub cool path" Preventing freeze under a heat exchanger. (Only 3HP to 6HP)

Compatible with pipes up to 75 meters long

Enable the outdoor unit to be installed out of sight increases installation flexibility.

SDI-Super Digital Inverter

Performance data

Out door unit	Standard model	(RAV-)	SP564ATP-SG	SP804ATP-SG	SP1104AT-SG	SP1404AT-SG
Indoor unit		(RAV-)	SM564UTP-E	SM804UTP-E	SM1104UTP-E	SM1404UTP-E
Cooling*1	Capacity	kW	4.8	5.8	9.7	11.2
	Range, min-max	kW	1.2-5.6	1.9-8.0	2.6-12.0	2.6-14.0
	Power consumption	kW	1.27	1.37	2.25	2.95
Power supply		1-phase 50Hz 230V (220-240V) / 1-phase 60Hz 220V				

Physical data	Indoor unit	(RAV-)	SM564UTP-E	SM804UTP-E	SM1104UTP-E	SM1404UTP-E
Standard air flow (H/M/L)	m³/h		1050/870/780	1230/960/810	2010/1440/1170	2100/1440/1230
Sound pressure level (H/M/L)	dB(A)		32/29/28	35/31/28	43/38/33	44/38/34
Main unit dimensions (H/W/D)	mm		256/840/840	256/840/840	319/840/840	319/840/840
Weight	kg		20	20	24	24
Panel dimensions (H/W/D)	mm		30/950/950	30/950/950	30/950/950	30/950/950
Panel weight	kg		4.2	4.2	4.2	4.2

Physical data	Equivalent HP	2HP	3HP	4HP	5HP	
Out door unit	Standard model	(RAV-)	SP564ATP-SG	SP804ATP-SG	SP1104AT-SG	SP1404AT-SG
Power supply		1-phase 50Hz 230V (220-240V)				
Compressor type		DC twin rotary				
Running Amphere	A	5.57	6.21	9.94	13.82	
Connecting pipe dia., Gas/Liquid side	mm	ø12.7 / ø6.4	ø15.9 / ø9.5	ø15.9 / ø9.5	ø15.9 / ø9.5	
Standard / Min. pipe length	m	7.5 / 5	7.5 / 5	7.5 / 3	7.5 / 3	
Max. pipe total length	m	50	50	75	75	
Maximum height difference	m	30	30	30	30	
Outer dimensions (H/W/D)	mm	550/780/290	890/900/320	1340/900/320	1340/900/320	
Weight	kg	44	66	93	93	
Standard air flow (Fan unit)	m³/h	2400	3000	6060	6180	
Sound pressure level, Cooling	dB(A)	47	48	49	51	
Operating range, Cooling/Heating	°C	15-43				



SDI Super Digital Inverter 2HP : Outdoor unit drawings

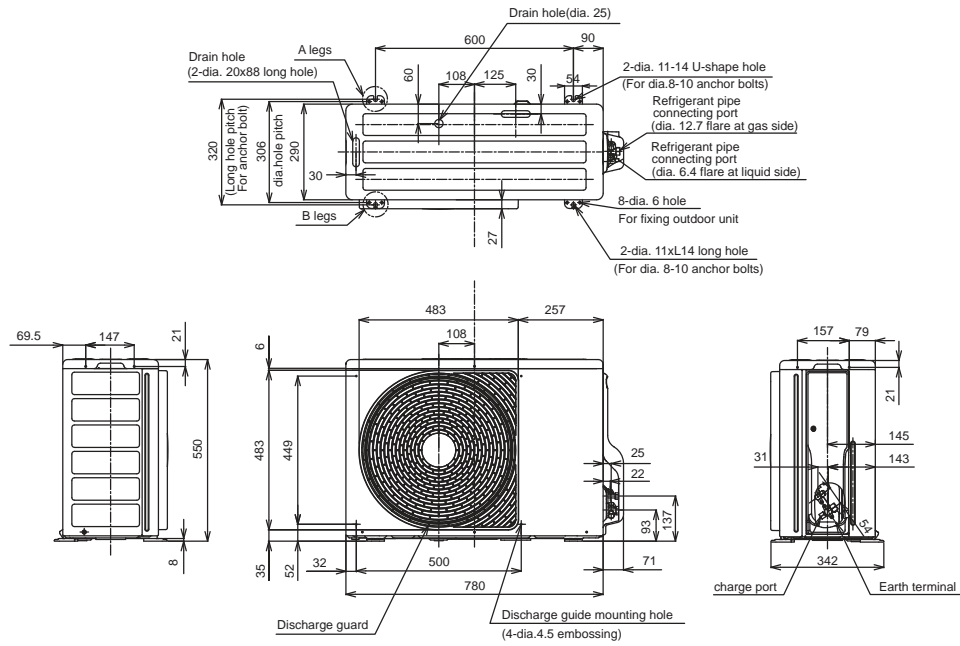

SDI Super Digital Inverter 3HP : Outdoor unit drawings

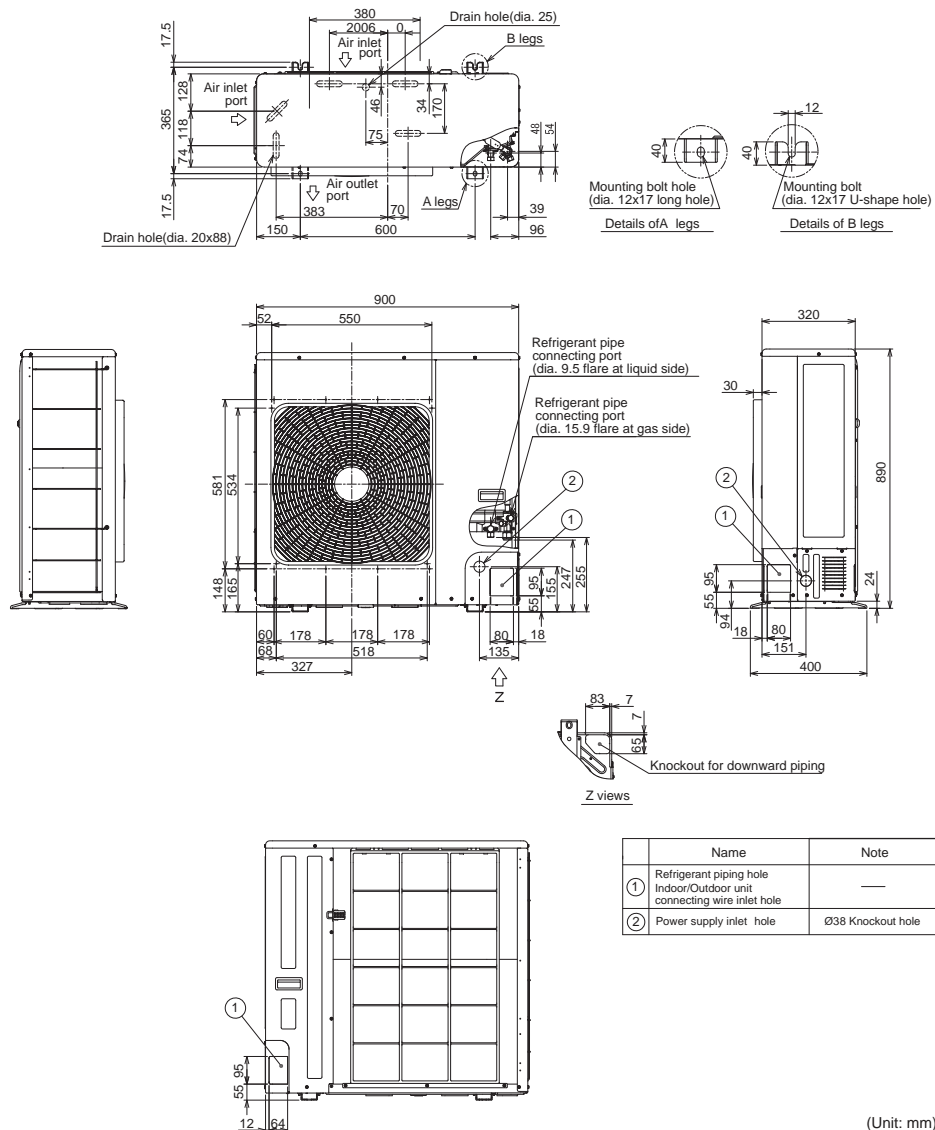

(Unit: mm)

SDI Super Digital Inverter 4&5HP : Outdoor unit drawings

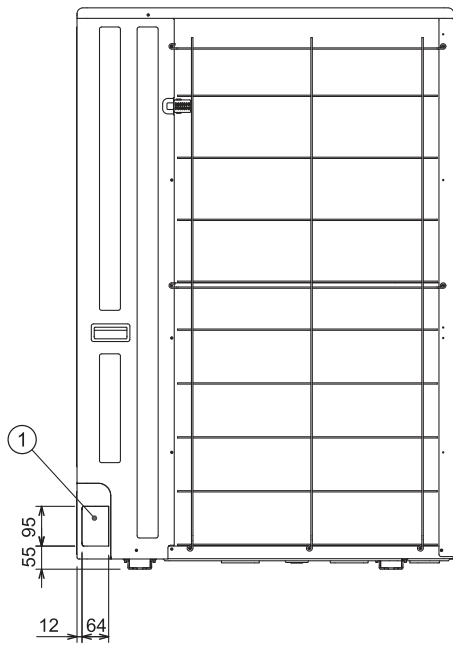
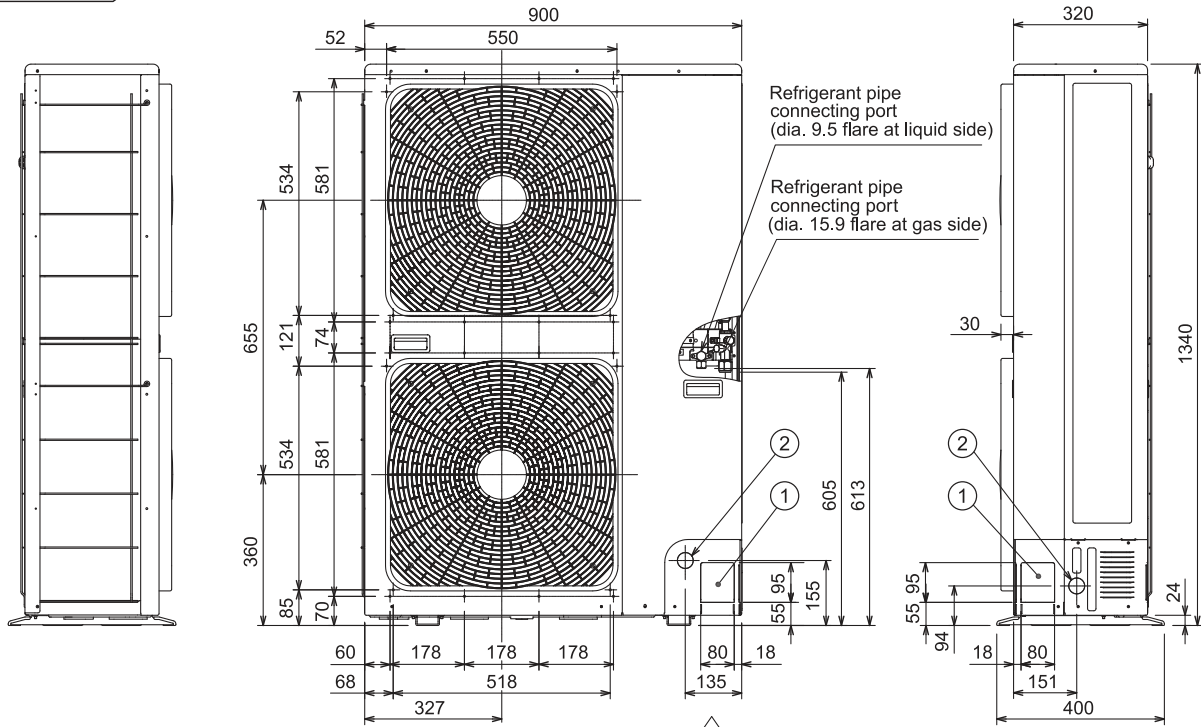
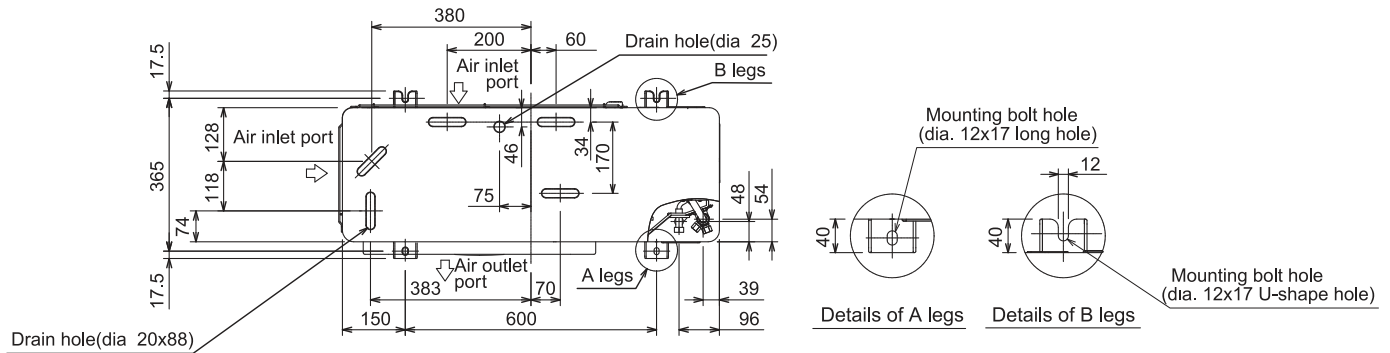

	Name	Note
①	Refrigerant piping hole Indoor/Outdoor unit connecting wire inlet hole	—
②	Power supply inlet hole	Ø38 Knockout hole

(Unit: mm)



***Made In Japan**

***Applicable to certain models**



Toshiba operations

Toshiba Air Conditioning main production facilities are based in Japan and Thailand.

Toshiba Carrier Corporation Japan

Toshiba's Fuji Works is the base for development of products that employ the latest in advanced air conditioner technologies.

The factory is blessed to be situated such that it looks out on the magnificent natural beauty of Mt. Fuji, Japan's tallest and most impressive mountain, and a symbol by which the nation is recognized.

Since commencing operations in 1943, Toshiba Fuji Works has been the birthplace of many excellent products, including the world's first split-type duct free air conditioner, and the world's first inverter split-type (duct free) air conditioner.

The factory is currently home to development and production of air conditioners for both residential and commercial customers: the compressors that serve as an air conditioner's heart, and the advanced inverters, a core component that adopts Toshiba's most advanced technologies.

Toshiba Carrier Thailand Corporation

Located in Pathumthani, approximately 40 km from Bangkok, is the base for the production of a wide range of Toshiba residential and light commercial products incorporating the latest technologies in energy efficiency.

Since the factory started its operations in 1989, the company has earned a significant number of quality, safety and environmental certifications. Toshiba air conditioners from Thailand factory are distributed in more than 50 countries around the world.

Excellent Energy Efficiency Ratio

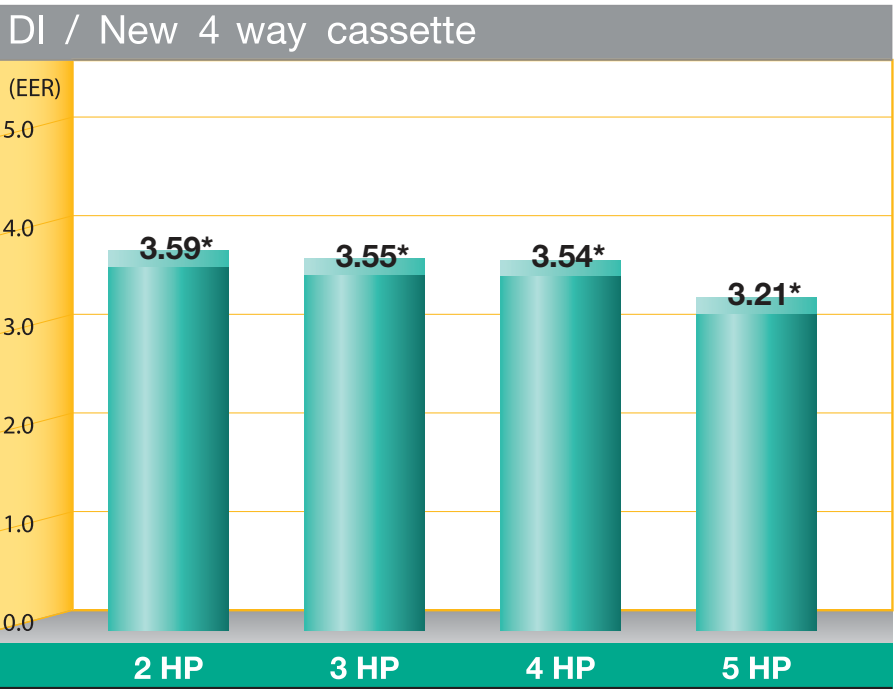
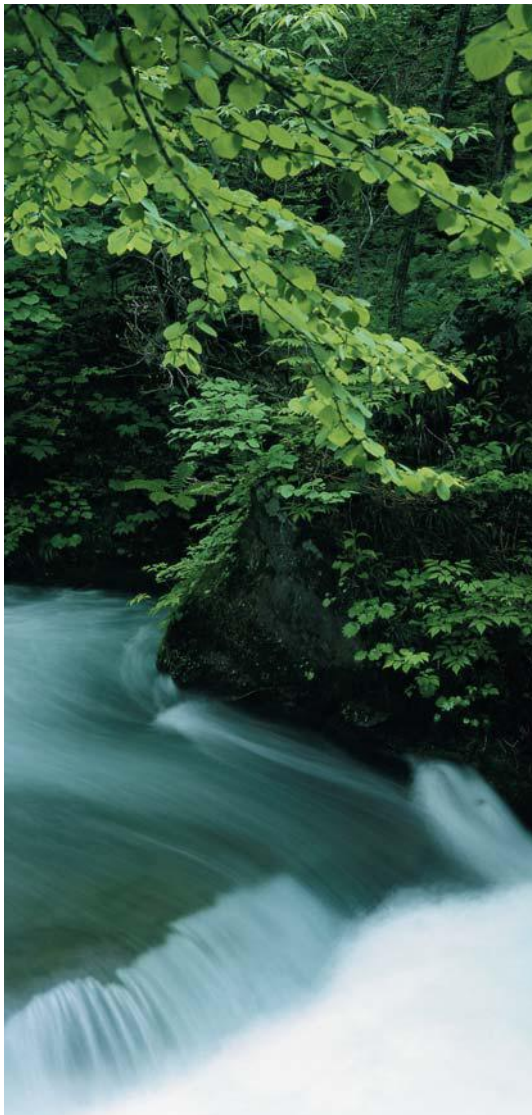

*At full load

Minimised operating costs and reduction in carbon emissions help to fight against global warming.



Efficient Energy

TOSHIBA AIR CONDITIONING
Advancing the **eco**-evolution



Toshiba Digital Inverter for Economy and Ecology

The Toshiba Digital Inverter air conditioners combine economy and ecology in a compact body. They feature state-of-the-art technology, flexible control, and easy installation to bring natural comfort and convenience to any business environment. With a wide selection of indoor units to suit your commercial applications, Toshiba Digital Inverter is certainly the economical and ecological way to go!



Innovative Inverter Technology

The innovative inverter technology is the heart of Toshiba Digital Inverter that achieves high power and high efficiency simultaneously.

When Toshiba Digital Inverter is switched on, the inverter control, assisted by PAW (Pulse Amplitude Modulation), rapidly reaches the desired temperature by increasing compressor frequency. When the desired temperature has been attained, the inverter control uses PWM (Pulse With Modulation) to adjust compressor rotation speed to efficiently maintain precise temperature control without consuming excess power.

By adopting this innovative inverter technology, Toshiba Digital Inverter offers remarkable energy-saving control, efficient economical operation, and excellent comfort.

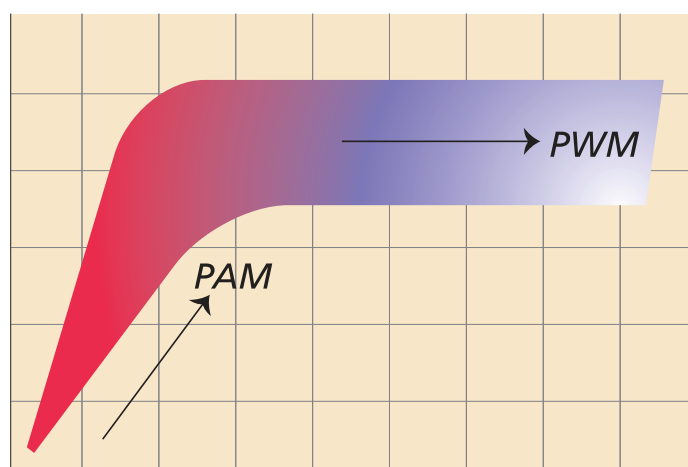
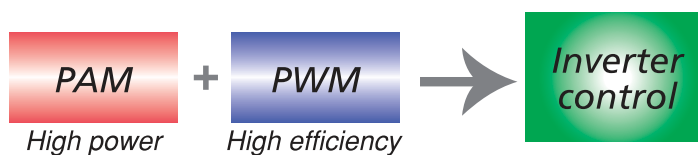



Inverter Air conditioners for Offices, Showrooms, Restaurants, Other Light Commercial and Household Applications

Optimum Comfort

Toshiba Digital Inverter's inverter technology maintains precise control of room temperature and creates a comfortable environment.

In conventional units, the compressor switches off once the set temperature is reached, and switches on again after the temperature drops. The time it takes for the unit to switch on and off causes the room temperature to greatly fluctuate.

With Toshiba Digital Inverter, the inverter control reduces the compressor power once the desired temperature has been reached, but continues operating at a reduced state to maintain a stable room temperature with minimal fluctuations.

By putting an end to on/off compressor operation, the inverter technology also allows Toshiba Digital Inverter to significantly reduce noise levels.

Digital Inverter

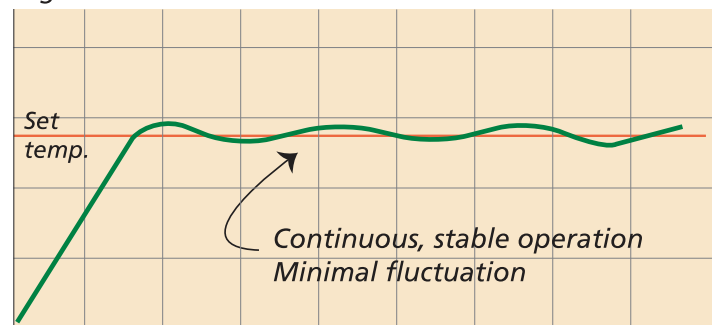

Conventional type

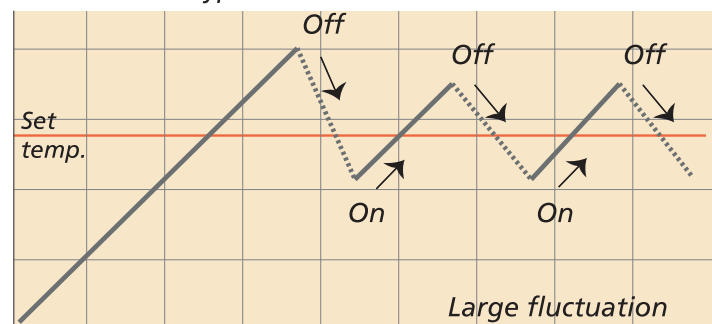

TOSHIBA

Leading Innovation >>>

Innovative Outdoor Units

Technology - Toshiba Digital Inverter's outdoor units are equipped with a rotary compressor and IPDU (Intelligent Power Drive Unit) for high reliability, high efficiency and low noise.

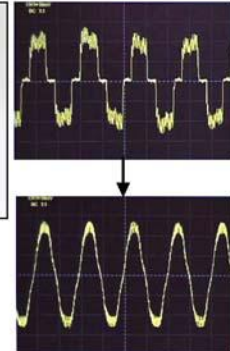

With vector IPDU control, noise emitted from the drive unit its greatly reduced by changing the motor current wave to a smooth sinusoidal pattern.



DC twin rotary compressor



Brushless Dc compressor motor

Small and lightweight - With the adoption of refrigerant R410, Toshiba Digital Inverter outdoor units now boast an ultra compact and lightweight design for easy and convenient installation.

RAV-SM563AT-SG
RAV-SM803AT-SG



Conventional 80 Kg \Rightarrow 42 kg **-38 kg**

RAV-SM1103AT-SG
RAV-SM1403AT-SG

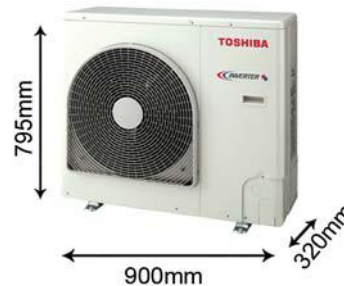

Conventional 109 Kg \Rightarrow 77kg **-32 kg**

Conventional

Digital Inverter

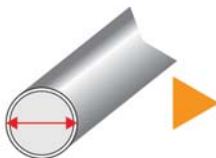

ø19.05



ø15.9

Easy Installation - In addition to being small and light weight, Toshiba Digital Inverter's outdoor units are fitted with a smaller diameter piping than conventional models. This means easier installation, shorter installation time and lower installation cost.

Various Indoor unit combination - Toshiba Digital Inverter outdoor units are compatible with a selection of indoor units to match a broad range of applications. Please consult Sales Department for more information.



Duct Type



High-wall Type



Ceiling Type



Cassette

Energy-Savings and Economy

Efficient energy use — Toshiba Digital Inverters' powerful yet highly efficient inverter technology features energy-saving operation that reduces annual power consumption by as much as 40% compared to conventional units.

The variable power levels of the compressor allows Toshiba Digital Inverter to evenly maintain the room temperature so that less energy is wasted. Moreover, without the surging on and shutting off of the compressor in conventional units, Toshiba Digital inverter can operate as low as 1.5kW*, saving a bundle of energy.

* In the case of cooling and heating capacity of the Digital Inverter 2HP 4-Way Cassette Type unit.

Superior COP — In terms of COP (Coefficient of Performance), all Toshiba Digital Inverter models greatly exceed the standard level.

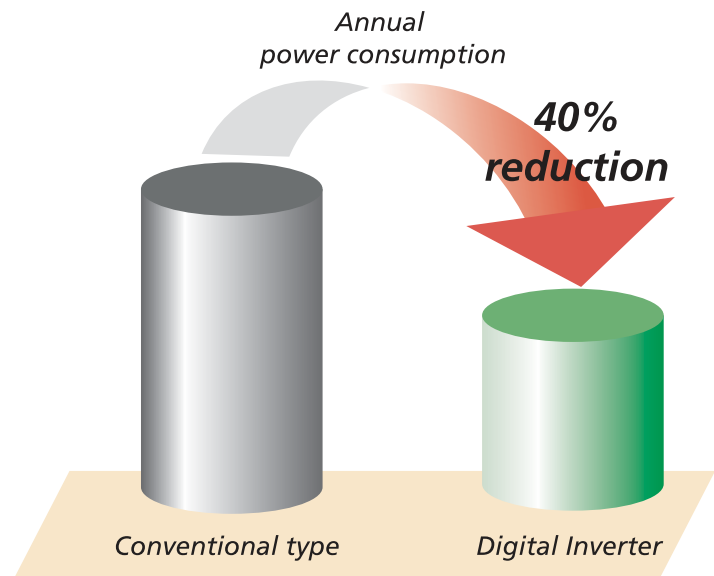

Digital Inverter

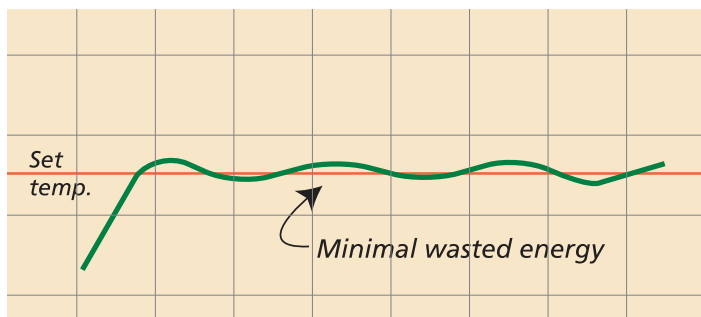

Conventional type

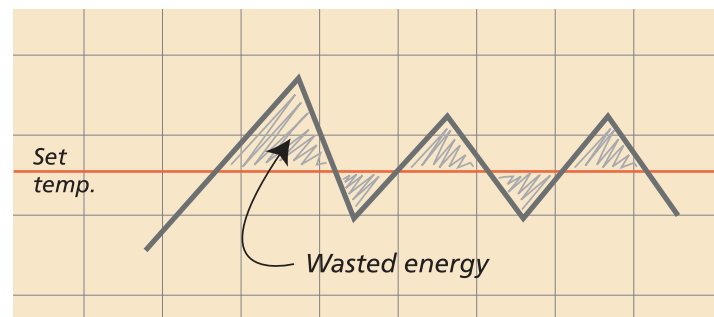

Ecologically-Sustainable

Toshiba Digital Inverter adopts environmentally-safe, non-ozone depleting R410A refrigerant, used for the first time in commercial air conditioners.

R410A refrigerant — In order to meet strict restrictions on the production of equipment that uses the R22 refrigerant used in most of commercial air conditioners today, R410A refrigerant was judged the most appropriate for Toshiba Digital Inverter units to contribute to environmental preservation.

	R410A	R407C
Ozone depletion potential (ODP)	0	0
Refrigerant capability (*comparison with R22)	147%	100%
Pressure loss (*comparison with R22)	56%	106%

DI Digital Inverter

The Powerful Benefits of Digital Inverter

1. Revolutionary 'Digital Inverter' technology assures reduced annual power consumption (up to 40%) over conventional 'fixed speed' units.
2. The indoor ambient conditions are maintained more uniformly at desired settings, in spite of variations in indoor or outdoor load conditions,
3. Year round comfort conditions with the automatic switch – over of Heating & Cooling mode in all types of Digital Inverter Indoor units.
4. Longer piping lengths which can cater to various site conditions.
5. Ecologically sustainable, Non-ozone Depleting R410A refrigerant used in all units.
6. Fully featured cordless remote available for all types of indoor units.
7. Group control and Central remote control options available for all units.
8. Systems are compatible to link up with Toshiba Super MMS and Mini SMMS systems used for large installations
9. Compact indoor & outdoor units with smallest foot print sizes. Easier & efficient to deliver & install.
10. Low starting current (<1Amp) reduces cost of power back ups & electrical accessories.



Cassette Type



Duct Type



High-wall Type



Ceiling Type



Line up

DI Series

	2HP	3HP	4HP	5HP
 RAV-SM563AT-SG 	 RAV-SM803AT-SG 	 RAV-SM1103AT-SG 	 RAV-SM1403AT-SG 	
4-way Cassette Type 	RAV-SM564UTP-E	RAV-SM804UTP-E	RAV-SM1104UTP-E	RAV-SM1404UTP-E
High-wall Type 	RAV-SM566KRT-E	RAV-SM806KRT-E	-	-
Duct Type 	RAV-SM566BTP-E	RAV-SM806BTP-E	RAV-SM1106BTP-E	RAV-SM1406BTP-E
Ceiling Type 	RAV-SM567CTP-E	RAV-SM8077CTP-E	RAV-SM11047CTP-E	RAV-SM14047CTP-E

4-way Cassette Type



Models

RAV-SM564UT-E
RAV-SM804UT-E
RAV-SM1104UT-E
RAV-SM1404UT-E

Panels

RBC-U31PG(W)-E

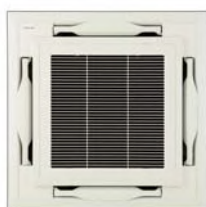

RBC-U31PG(W)-E

Wireless remote controller kit

RBC-AX32U(W)-E



*Wired remote controller (Optional)

Temperature conditioning

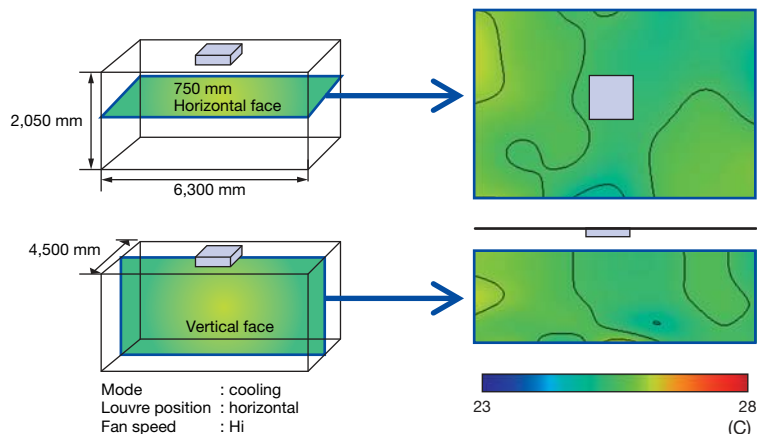

Individual Louvre Control

The angles of each of the four louvres can be set individually
△ Enables airflow to be chosen according to user's preferences.

Three louvre swing patterns

(1) Standard swing



(2) Diagonally opposite swing



(3) Turn-around wing

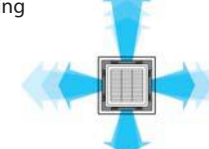

Note: Need to set from wired remote controller

Easy installation

The panel is attached using the bolt that is already installed on the indoor unit.



Comfort



Inverter
Allows step-less regulation of the air-conditioner's power, which reduces energy consumption and improves comfort.



Long-life Filter
Built-in long-life filter makes maintenance easier.



Individual louvre control
Enables airflows to be chosen according to user's preferences.



Hot Start
When using the heater for preheating or defrosting, stops the indoor fan to prevent cold air from being blown into the room.



Auto-turn Louvres
Air outlet grilles move automatically to fill every corner of the room with warm or cool air.



Automatic Cooling/Heating
Automatically switches between cooling and heating mode.



Automatic Air Volume Control
Depending on the difference between the room temperature and the set temperature, switches automatically between High, Low and Very Low.



Dry
Gradually dehumidifies the room to create even greater comfort.

Operativity



Filter Sign
Automatic displays on the remote controller say when to perform maintenance for the indoor unit filter.



Limit Timer
Uses a 168-hour timer with three modes – "On timer", "OFF timer" and "Repeat OFF timer".

Installation



Cooler Compatible with an Outdoor Temperature of -15°C
Stable cooler operation is possible when the outdoor temperature is as low as -15°C



Built-in Drain Pump
The built-in drain pump makes draining easier. (In the ceiling cassette type, it is built in to the main unit.)

1. combination

type	4way cassette				4way cassette (with twin kit)		
	DI	DI	DI	DI	DI	DI	
system-type	DI	DI	DI	DI	DI	DI	
indoor-type	4way	4way	4way	4way	4way	4way	
capacity	hp	2.0	3.0	4.0	5.0	2.0	3.0
indoor		RAV-SM564UTP-E	RAV-SM804UTP-E	RAV-SM1104UTP-E	RAV-SM1404UTP-E	RAV-SM564UTP-E	RAV-SM804UTP-E
Qty-indoor unit		1	1	1	1	2	2
outdoor		RAV-SM563AT-SG	RAV-SM803AT-SG	RAV-SM1103AT-SG	RAV-SM1403AT-SG	RAV-SM1103AT-SG	RAV-SM1403AT-SG
controller (wireless)		RBC-AX31U(W)-E					
cooling capacity-rated	kW	5.1	6.1	9.7	12.5	5.1	6.1
cooling capacity-range	kW	<1.5 - 5.6>	<1.5 - 8.0>	<3.0 - 11.2>	<3.0 - 13.2>	<1.5 - 5.6 >	<1.5 - 8.0 >
cooling power input-rated	kW	1.42	1.72	2.74	3.74	1.42	1.72
NEA tick	tick	√/	√/	√/	√	√/	√
running current (230V)	A	6.54	8.14	12.53	16.8	6.54	8.14
flare connection main pipe (gas)	mm	12.7	15.9	15.9	15.9	12.7	15.9
flare connection main pipe (liquid)	mm	6.4	9.5	9.5	9.5	6.4	9.5
pipe length (min)	m	5	5	5	5	5	5
pipe length (max)	m	30	30	50	50	30	30
chargeless length	m	20	20	30	30	20	20
brand kit						RBC-TWP30E2	RBC-TWP50E2

2. indoors

model name		RAV-SM564UTP-E	RAV-SM804UTP-E	RAV-SM1104UTP-E	RAV-SM1404UTP-E	RAV-SM564UTP-E × 2	RAV-SM804UTP-E × 2
indoor		4way	4way	4way	4way	4way	4way
capacity	hp	2.0	3.0	4.0	5.0	2.0	3.0
air flow-H	m3/h	1,050	1,230	2,010	2,100	1,050	1,230
air flow-M	m3/h	870	960	1,440	1,440	870	960
air flow-L	m3/h	780	810	1,170	1,230	780	810
sound pressure level (L)/(M)/(H)	dB	28 / 29 / 32	28 / 31 / 35	33 / 38 / 43	34 / 38 / 44	28 / 29 / 32	28 / 31 / 35
dimension (H X W X D)	mm	256 × 840 × 840	256 × 840 × 840	319 × 840 × 840	319 × 840 × 840	256 × 840 × 840	256 × 840 × 840
weight	kg	20	20	24	24	20	20
panel model name		RBC-U31PG(W)-E	RBC-U31PG(W)-E	RBC-U321PG(W)-E	RBC-U31PG(W)-E	RBC-U31PG(W)-E	RBC-U31PG(W)-E
panel dimension (H × W × D)	mm	30 × 950 × 950	30 × 950 × 950	30 × 950 × 950	30 × 950 × 950	30 × 950 × 950	30 × 950 × 950
panel weight	kg	4.2	4.2	4.2	4.2	4.2	4.2
fan type		turbo fan	turbo fan	turbo fan	turbo fan	turbo fan	turbo fan
fan motor	W	14	20	68	72	14	20
air filler		Long life filter	Long life filter	Long life filter	Long life filter	Long life filter	Long life filter
attached remote controller (wireless)		RBC-AX32U(W)-E					
power input-max(for name Plate)	W	40	40	120	120	40	40

3. outdoor

model name		RAV-SM563AT-SG	RAV-SM803AT-SG	RAV-SM1103AT-SG	RAV-SM1403AT-SG	RAV-SM1103AT-SG	RAV-SM1403AT-SG
outdoor-type		DI	DI	DI	DI	DI	DI
capacity	hp	2.0	3.0	4.0	5.0	4.0	5.0
phase		1	1	1	1	1	1
power supply	V	230	230	230	230	230	230
power supply (Hz)	Hz	50	50	50	50	50	50
air-flow	m3/hr	2,400	2,700	4,500	4,500	4,500	4,500
sound pressure level	dB	46	48	53	54	53	54
dimension (H × W × D)	mm	550 × 780 × 290	550 × 780 × 290	795 × 900 × 320	795 × 900 × 320	795 × 900 × 320	795 × 900 × 320
weight	kg	38	44	77	77	77	77
compressor type		DC Twin Rotary	DC Twin Rotary	DC Twin Rotary	DC Twin Rotary	DC Twin Rotary	DC Twin Rotary
fan motor output	kw	43	43	100	100	100	100
Refrigerant Quantity in Outdoorunit	kg	1.0	1.7	2.8	2.8	2.8	2.8
Additional refrigerant charge	g/m	20	40	40	40	40	40
power input-max(for NamePlate)	kw	2.49	3.41	4.75	4.87	4.75	4.87
installation fuse rating	A	16	16	25	25	25	25
power wire	mm2	1.5	1.5	2.5	2.5	2.5	2.5
indoor/outdoor connecting wire	mm2	1.5	1.5	1.5	1.5	1.5	1.5

High-wall Type



Models

RAV-SM566KRT-E
RAV-SM806KRT-E

Wireless remote controller

WH-L11SE



Features

With its attractive, slim-line design, this unit is best suited for restaurants and other applications where elegance is required. The filtration system further improves the indoor air quality benefits of this high-wall unit.

Key features

With its slim design, this compact and stylish unit blends into any room setting.

Enhanced filtration system: Zeolite Plus + Sasa filter to deodorise, Bio-Enzyme filter + Ginkgo filter to purify and a new antioxidant Vitamin C filter.

Auto-louvre mode allows optimum air distribution throughout the room.

A wireless controller is included.

a TCC Link remote control is optional.

Comfort



Inverter

Allows step-less regulation of the air-conditioner's power, which reduces energy consumption and improves comfort.



Auto-turn Louvres

Air outlet grilles move automatically to fill every corner of the room with warm or cool air.



Automatic Air Volume Control

Depending on the difference between the room temperature and the set temperature, switches automatically between High, Low and Very Low.



Hot Start

When using the heater for preheating or defrosting, stops the indoor fan to prevent cold air from being blown into the room.



Automatic Cooling/Heating

Automatically switches between cooling and heating mode.



Dry

Gradually dehumidifies the room to create even greater comfort.

Operativity



On/Off Timer

The operation start and stop times can be set with a digital clock



Cooler Compatible with an Outdoor Temperature of -15°C

Stable cooler operation is possible when the outdoor temperature is as low as -15°C

1. combination

type		Hi Wall		Hi Wall (with Twin Kit)	
		DI	DI	DI	DI
system-type	DI	DI	DI	DI	DI
indoor-type		high wall	high wall	high wall	high wall
capacity	hp	2.0	3.0	2.0	3.0
indoor		RAV-SM566KRT-E	RAV-SM806KRT-E	RAV-SM566KRT-E	RAV-SM806KRT-E
Qty-indoor unit		1	1	2	2
outdoor		RAV-SM563AT-SG	RAV-SM803AT-SG	RAV-SM1103AT-E	RAV-SM1403AT-E
cooling capacity-rated	kW	5.1	6.1	5.1	6.1
cooling capacity-range	kW	< 1.5 - 5.6 >	< 1.5 - 8.0 >	< 1.5 - 5.6 >	< 1.5 - 8.0 >
cooling power input-rated	kW	1.42	1.74	1.42	1.74
NEA tick	tick	√√	√√	√√	√
running current (230V)	A	6.54	8.14	6.54	8.14
flare connection main pipe (gas)	mm	12.7	15.9	12.7	15.9
flare connection main pipe (liquid)	mm	6.4	9.5	6.4	9.5
pipe length (min)	m	5	5	5	5
pipe length (max)	m	30	30	30	30
chargeless length	m	20	20	20	20
branch kit				RBC-TWP30E2	RBC-TWP50E2

2. indoors

model name		RAV-SM566KRT-E	RAV-SM806KRT-E	RAV-SM566KRT-E × 2	RAV-SM806KRT-E × 2
indoor-type		high wall	high wall	high wall	high wall
capacity	hp	2.0	3.0	2	3
air flow-H	m ³ /h	840	1,020	840	1,020
air flow-M	m ³ /h	750	750	750	750
air flow-L	m ³ /h	660	660	842	660
sound pressure level (L) / (M) / (H)	dB	36 / 39 / 42	36 / 41 / 47	36 / 39 / 42	36 / 41 / 47
dimension (H × W × D)	mm	320 × 1050 × 228	320 × 1050 × 228	320 × 1050 × 228	320 × 1050 × 228
weight	kg	12	12	12	12
fan type		cross flow fan	cross flow fan	cross flow fan	cross flow fan
fan motor output	W	30	30	30	30
air filter		Attached	Attached	Attached	Attached
attached remote controller (wireless)		WH-L11SE	WH-L11SE	WH-L11SE	WH-L11SE
power input-max(for NamePlate)	W	50	70	50	70

3. outdoors

model name		RAV-SM563AT-SG	RAV-SM803AT-SG	RAV-SM1103AT-SG	RAV-SM1403AT-SG
outdoor-type	DI	DI	DI	DI	DI
capacity	hp	2.0	3.0	4	5
phase	1	1	1	1	1
power supply	v	230	230	230	230
power supply (Hz)	Hz	50	50	50	50
air flow	m ³ /h	2,400	2,700	4,500	4,500
sound pressure level	dB	46	48	53	54
dimension (H × W × D)	mm	550 × 780 × 290	550 × 780 × 290	795 × 900 × 320	795 × 900 × 320
weight	kg	38	44	77	77
compressor type		DC Twin Rotary	DC Twin Rotary	DC Twin Rotary	DC Twin Rotary
fan motor output	W	43	43	100	100
Refrigerant Quantity in Outdoorunit	kg	1.0	1.7	2.8	2.8
Additional refrigerant charge	g/m	20	40	40	40
power input-max(for NamePlate)	kw	2.49	3.41	4.75	4.87
installation fuse rating	A	16	16	25	25
power wire	mm ²	1.5	1.5	2.5	2.5
indoor/outdoor connecting wire	mm ²	1.5	1.5	1.5	1.5

Versatile and Clever Duct Type



Models

RAV-SM566BTP-E
RAV-SM806BTP-E
RAV-SM1106BTP-E
RAV-SM1406BTP-E

Wired remote controller

RBC-AMT32E



*Wireless remote controller
(Optional)

Wide range of applications

The use of ducts allows air outlets to be conveniently installed anywhere on the ceiling, eliminating the conspicuous presence of the air conditioner in the center of the room. Not only can this be applied to a wide variety of layouts from narrow spaces to polygonal rooms; it also greatly improves the aesthetics of a room with its unobtrusive presence.

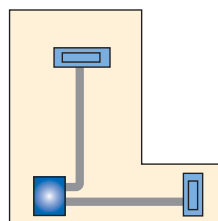

Polygonal rooms

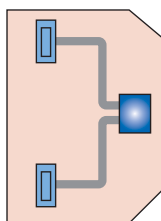

Narrow rooms

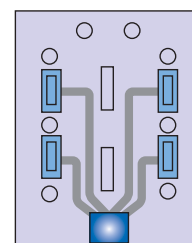
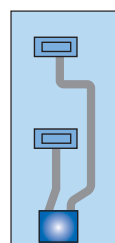

Rooms with fixtures and
obstacles

High static pressure

External static pressure can be raised as high as 120pa (max), so that all areas of the room can be reached for even temperature distribution, no matter how complex the layout.

High-lift drain pump

The flexible piping layout is made possible by an optionally available drain-pump kit that raises the drain piping up to 27 cm from the drain port.

New slimmer chasis with higher static pressure

Reduce from 320mm to 275mm height.

Comfort



Inverter
Allows step-less regulation of the air-conditioner's power, which reduces energy consumption and improves comfort.



Automatic Air Volume Control
Depending on the difference between the room temperature and the set temperature, switches automatically between High, Low and Very Low.



Long-life Filter
Built-in long-life filter makes maintenance easier



Hot Start
When using the heater for preheating or defrosting, stops the indoor fan to prevent cold air from being blown into the room.



Automatic Cooling/Heating
Automatically switches between cooling and heating mode.



Dry
Gradually dehumidifies the room to create even greater comfort.

Operativity



Filter Sign
Automatic displays on the remote controller say when to perform maintenance for the indoor unit filter.



Limit Timer
Uses a 168 hour timer with three modes — "ON timer", "OFF timer" and "Repeat OFF timer"

Installation



Cooler Compatible with an Outdoor Temperature of -15°C
Stable cooler operation is possible when the outdoor temperature is as low as -15°C



Built-in Drain Pump
The built-in drain pump makes draining easier (in the ceiling cassette type, it is built in to the main unit.)

1. combination

type	Standard ducted				Standard ducted (with Twin Kit)		
	DI	DI	DI	DI	DI	DI	
system-type	duct	duct	duct	duct	duct	duct	
indoor-type	duct	duct	duct	duct	duct	duct	
capacity rank	hp	2.0	3.0	4.0	5.0	2.0	
indoor		RAV-SM566BTP-E	RAV-SM806BTP-E	RAV-SM1106BTP-E	RAV-SM1406BTP-E	RAV-SM566BTP-E	RAV-SM806BTP-E
Qty-indoor unit		1	1	1	1	2	2
outdoor		RAV-SM563AT-SG	RAV-SM803AT-SG	RAV-SM1103AT-SG	RAV-SM1403AT-SG	RAV-SM1103AT-SG	RAV-SM1403AT-SG
controller (wired)		RBC-AMT32E	RBC-AMT32E	RBC-AMT32E	RBC-AMT32E	RBC-AMT32E	RBC-AMT32E
cooling capacity-rated	kW	5.1	6.1	9.7	12.5	5.1	6.1
cooling capacity-range	kW	< 1.5 - 5.6 >	< 1.5 - 8.0 >	< 3.0 - 11.2 >	< 3.0 - 13.2 >	< 1.5 - 5.6 >	< 1.5 - 8.0 >
cooling power input-rated	kW	1.42	1.72	2.74	3.74	1.42	1.72
NEA tick	tick	√/	√/	√/	√	√/	√
running current (230V)	A	6.54	8.14	12.53	16.8	6.54	8.14
flare connection main pipe (gas)	mm	12.7	15.9	15.9	15.9	12.7	15.9
flare connection main pipe (liquid)	mm	6.4	9.5	9.5	9.5	6.4	9.5
pipe length (min)	m	5	5	5	5	5	5
pipe length (max)	m	30	30	50	50	30	30
chargeless length	m	20	20	30	30	20	20
branch kit						RBC-TWP30E2	RBC-TWP50E2

2. indoors

model name		RAV-SM566BTP-E	RAV-SM806BTP-E	RAV-SM1106BTP-E	RAV-SM1406BTP-E	RAV-SM566BTP-E × 2	RAV-SM806BTP-E × 2
indoor-type		duct	duct	duct	duct	duct	duct
capacity	hp	2.0	3.0	4.0	5.0	2.0	3.0
air flow-H	m³/h	800	1,200	2,100	2,100	N.A	N.A
air flow-M	m³/h	630	930	1,650	1,650	N.A	N.A
air flow-L	m³/h	480	720	1,260	1,260	N.A	N.A
sound pressure level (L)/(M)/(H)	dB	25 / 29 / 33	26 / 30 / 34	33 / 36 / 40	33 / 36 / 40	25 / 29 / 33	26 / 30 / 34
dimension (H × W × D)	mm	275 × 700 × 750	275 × 1000 × 750	275 × 1400 × 750	275 × 1400 × 750	275 × 700 × 750	275 × 1000 × 750
weight	kg	23	30	40	40	40	40
external static pressure (std)	Pa	40	40	40	40	40	40
external static pressure (upper)	Pa	120	120	120	120	120	120
external static pressure (lower)	Pa	30	30	30	30	30	30
fan type		centrifugal fan	centrifugal fan	centrifugal fan	centrifugal fan	centrifugal fan	centrifugal fan
fan motor output		120	120	120	120	120	120
air filter		Long life filter	Long life filter	Long life filter	Long life filter	Long life filter	Long life filter
attached remote controller (wired)		RBC-AMT32E	RBC-AMT32E	RBC-AMT32E	RBC-AMT32E	RBC-AMT32E	RBC-AMT32E
power input-max(for NamePlate)	w	150	150	250	250	150	150

3. outdoors

model name		RAV-SM563AT-SG	RAV-SM803AT-SG	RAV-SM1103AT-SG	RAV-SM1403AT-SG	RAV-SM1103AT-SG	RAV-SM1403AT-SG
outdoor-type		DI	DI	DI	DI	DI	DI
capacity rank	hp	2.0	3.0	4.0	4.0	5.0	5.0
phase		1	1	1	1	1	1
power supply	v	230	230	230	230	230	230
power supply (Hz)	Hz	50	50	50	50	50	50
air flow	m³/h	2,400	2,700	4,500	4,500	4,500	4,500
sound pressure level (cooling)	dB	46	48	53	54	53	54
dimension (H × W × D)	mm	550 × 780 × 290	550 × 780 × 290	795 × 900 × 320	795 × 900 × 320	795 × 900 × 320	795 × 900 × 320
weight	kg	38	44	77	77	77	77
compressor type		DC Twin Rotary	DC Twin Rotary	DC Twin Rotary	DC Twin Rotary	DC Twin Rotary	DC Twin Rotary
fan motor output	kw	43	43	100	100	100	100
Refrigerant Quantity in Outdoor unit	kg	1.0	1.7	2.8	2.8	2.8	2.8
Additional refrigerant charge	g/m	20	40	40	40	40	40
power input-max(for NamePlate)	kw	2.49	3.41	4.75	4.87	4.75	4.87
installation fuse rating	A	16	16	25	25	25	25
power wire	mm²	1.5	1.5	2.5	2.5	2.5	2.5
indoor/outdoor connecting wire	mm²	1.5	1.5	1.5	1.5	1.5	1.5

Quiet and Comfortable Ceiling Type



Models

- RAV-SM567CTP-E
- RAV-SM807CTP-E
- RAV-SM1107CTP-E
- RAV-SM1407CTP-E

Wired remote controller

RBC-AMT32E



*Wireless remote controller (Optional)

Comfortable ambience

Quietest in industry

A new design has been adopted that greatly reduces the noise level to half that of conventional units. Operation is always whisper-quiet.

Flap control

The airflow angle is automatically set to the most suitable setting according to your cooling or heating needs, and an automatic swing mode enables airflow to reach all areas of the room to create a comfortable ambience.

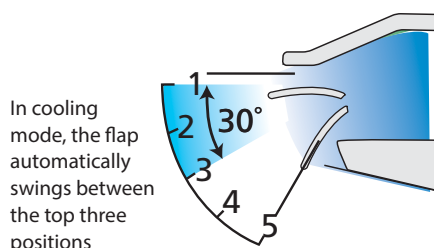

In cooling mode, the flap automatically swings between the top three positions

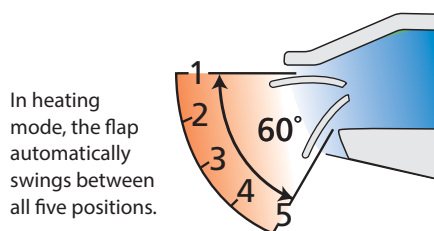

In heating mode, the flap automatically swings between all five positions.

Installation efficiency

Suspending the unit from the ceiling saves the trouble of complex installation procedures. It can be suspended simply by adjusting two screws on the intake grill. Compared to conventional units which involve a dozen screws, installation is further simplified.

Comfort



Inverter
Allows step-less regulation of the air-conditioner's power, which reduces energy consumption and improves comfort.



Hot Start
When using the heater for preheating or defrosting, stops the indoor fan to prevent cold air from being blown into the room.



Automatic Air Volume Control
Depending on the difference between the room temperature and the set temperature, switches automatically between High, Low and Very Low.



Auto-turn Louvers
Air outlet grilles move automatically to fill every corner of the room with warm or cool air.



Long-life Filter
Built-in long-life filter makes maintenance easier



Dry
Gradually dehumidifies the room to create even greater comfort.

Operativity



Filter Sign
Automatic displays on the remote controller say when to perform maintenance for the indoor unit filter.



Limit Timer
Uses a 168 hour timer with three modes — "ON timer", "OFF timer" and "Repeat OFF timer"

Installation



Cooler Compatible with an Outdoor Temperature of -15°C
Stable cooler operation is possible when the outdoor temperature is as low as -15°C



Built-in Drain Pump
The built-in drain pump makes draining easier (in the ceiling cassette type, it is built in to the main unit.)

1. combination

type		Under ceiling				Under ceiling (with Twin Kit)	
		DI	DI	DI	DI	DI	DI
system-type		DI	DI	DI	DI	DI	DI
indoor-type		ceiling	ceiling	ceiling	ceiling	ceiling	ceiling
capacity	hp	2.0	2.0	4.0	5.0	2.0	3.0
indoor		RAV-SM567CTP-E	RAV-SM807CTP-E	RAV-SM1107CTP-E	RAV-SM1407CTP-E	RAV-SM567CTP-E	RAV-SM807CTP-E
Qty-indoor unit		1	1	1	1	2	2
outdoor		RAV-SM563AT-SG	RAV-SM803AT-SG	RAV-SM1103AT-SG	RAV-SM1403AT-SG	RAV-SM1103AT-SG	RAV-SM1403AT-SG
controller (wired)		RBC-AMT32E	RBC-AMT32E	RBC-AMT32E	RBC-AMT32E	RBC-AMT32E	RBC-AMT32E
cooling capacity-rated	kW	5.1	6.1	9.7	12.5	5.1	6.1
cooling capacity-range		< 1.5 - 5.6 >	< 1.5 - 8.0 >	< 3.0 - 11.2 >	< 3.0 - 13.2 >	< 1.5 - 5.6 >	< 1.5 - 8.0 >
cooling power input-rated	kW	1.42	1.72	2.74	3.74	1.42	1.72
NEA tick	tick	√/√	√/√	√/√	√	√/√	√
running current (230V)	A	6.54	8.14	12.53	16.8	6.54	8.14
flare connection mian pipe (gas)	mm	12.7	15.9	15.9	15.9	12.7	15.9
flare connection main pipe (liquid)	mm	6.4	9.5	9.5	9.5	6.4	9.5
pipe length (min)	m	5	5	5	5	5	5
pipe length (max)	m	30	30	50	50	30	30
chargeless length	m	20	20	30	30	20	20
branch kit						RBC-TWP30E2	RBC-TWP50E2

2. indoors











model name		RAV-SM567CTP-E	RAV-SM807CTP-E	RAV-SM1107CTP-E	RAV-SM1407CTP-E	RAV-SM567CTP-E × 2	RAV-SM807CTP-E × 2
indoor-type		ceiling	ceiling	ceiling	ceiling	ceiling	ceiling
capacity rank	hp	2.0	3.0	4.0	5.0	2.0	3.0
air flow-H	m³/h	900	1,410	1,860	2,040	900	1,410
air flow-M	m³/h	720	1,002	1,350	1,530	720	1,002
air flow-L	m³/h	540	750	1,020	1,200	540	750
air-flow-H	m³/min	15.0	23.5	31.0	34.0	15.0	23.5
air-flow-M	m³/min	12.0	16.7	22.5	25.5	12.0	16.7
air-flow-L	m³/min	9.0	12.5	17.0	20.0	9.0	12.5
sound pressure level (L)/(M)/(H)	dB	28/35/37	29/36/41	32/38/44	35/41/46	28/35/37	29/36/41
dimmension (H × W × D)	mm	235 × 950 × 690	235 × 1,270 × 690	235 × 1,586 × 690	235 × 1,586 × 690	235 × 950 × 690	235 × 1,270 × 690
weight	kg	23	29	35	35	23	29
fan type		centrifugal fan	centrifugal fan	centrifugal fan	centrifugal fan	centrifugal fan	centrifugal fan
fan motor output	W	94	94	139	139	94	94
air filter		Long life filter	Long life filter	Long life filter	Long life filter	Long life filter	Long life filter
attached remote controller (wired)		RBC-AMT32-E	RBC-AMT32-E	RBC-AMT32-E	RBC-AMT32-E	BBC-AMT32-E	BBC-AMT32-E
power input-max(for NamePlate)	W	94	94	150	150	94	94

3. outdoors

model name		RAV-SM563AT-SG	RAV-SM803AT-SG	RAV-SM1103AT-SG	RAV-SM1403AT-SG	RAV-SM1103AT-SG	RAV-SM1403AT-SG
outdoor-type		DI	DI	DI	DI	DI	DI
capacity rank		2.0	3.0	4.0	5.0	4.0	5.0
phase		1	1	1	1	1	1
power supply	v	230	230	230	230	230	230
power supply	(Hz)	50	50	50	50	50	50
air flow	m³/h	2,400	2,700	4,500	4,500	4,500	4,500
sound pressure level (cooling)	dB	46	48	53	54	53	54
dimension (H × W × D)	mm	550 × 780 × 290	550 × 780 × 290	795 × 900 × 320	795 × 900 × 320	795 × 900 × 320	795 × 900 × 320
weight	kg	38	44	77	77	77	77
compressor type		DC Twin Rotary	DC Twin Rotary	DC Twin Rotary	DC Twin Rotary	DC Twin Rotary	DC Twin Rotary
fan motor output	kw	43	43	100	100	100	100
Refrigerant Quantity in Outdoor unit	kg	1.0	1.7	2.8	2.8	2.8	2.8
Additional refrigerant charge	g/m	20	40	40	40	40	40
power wire	mm²	1.5	1.5	2.5	2.5	2.5	2.5
indoor/outdoor connecting wire		1.5	1.5	1.5	1.5	1.5	1.5

Remote Controllers

Toshiba Digital Inverters operated with an easy-to-use remote controller.

Indoor unit	4-Way Cassette RAV-SM**4UTP-E 	Ducted RAV-SM**6BTP-E 	Under Ceiling RAV-SM**7CTP-E 	High-Wall RAV-SM**6KRT-E 
Remoto controller RBC-AX32U(W)-E Wireless remote controller kit 	*			
RBC-AX32CE2 Wireless remote controller kit 			*	
TCB-AX32E2 Wireless remote controller kit 		*		*
RBC-AMS51E-EN Lite-Vision plus remote controlle 	*	*	*	*
RBC-AMT32E Wired remote controller 	*	*	*	*
RBC-EXW21E Weekly timer 	*	*	*	*
TCB-SC642TLE2 Central remote controller 	*	*	*	*

Note: To link to CRC Control, a net adapter interface card is required - model TCB-PCNT30TLE2

Cost Saving



Comfort



An efficient use of time



TOSHIBA

TCC-SDI 2016/05

Notice : Toshiba is committed to continuously improving its products, to ensure the highest quality and reliability standards, and to meet local regulations and market requirements. All features and specifications subject to change without prior notice

